

Twist Reverse Osmosis Drinking Water System

AQUA TEK





INNOVATIVE WATER PRODUCTS



AQUATEK ATPRO-50 PRO-SERIES REVERSE OSMOSIS SYSTEM

Installation & Instruction Manual

Initial Inspection 3
 Operation Parameters..... 4
 Plumbing Schematic..... 5
 Pre-Installation 6
 Faucet Installation..... 6-8
 Feed Water Adapter Installation 8-9
 Self-Piercer Installation..... 10
 Flowlok Leak Control Valve 10
 Drain Saddle Installation 11
 Tank Placement..... 11
 R.O. Unit Placement & Mounting 12
 Tubing Connections 12-14
 System Start-Up 15
 Flushing the R.O. System 15
 Filter Replacement 16
 Replacement Filters 17
 Pump Hook Up 18
 Troubleshooting 18-20
 Liability & Warranty..... 23

LEGEND	
	CAUTION / WARNING
	EYE PROTECTION
	ELECTRICAL WARNING
	FRAGILE



WARNING: READ ENTIRE MANUAL. FAILURE TO FOLLOW ALL GUIDES AND RULES COULD CAUSE PERSONAL INJURY OR PROPERTY DAMAGE.

Check with your state and/or local public works department for plumbing codes. You must follow their guides as you install the Water Filtration system.

NOTE: Failure to comply with these installation instructions will void the product Warranty, and the installer will be responsible for any service, repair or damages caused thereby.



WARNING: DO NOT USE WITH WATER THAT IS MICROBIOLOGICALLY UNSAFE OR OF UNKNOWN QUALITY WITHOUT ADEQUATE DISINFECTION BEFORE OR AFTER THE SYSTEM.

TOOLS & MATERIALS NEEDED FOR NORMAL INSTALLATION:

- Cordless Drill
- Carbide grinding burr
- 1/4" (6 mm) drill bit
- 7/16" (11 mm) drill bit
- 1/2" (13 mm) and 5/8" (16 mm) open-end wrenches (or adjustables)

FOR ATPRO-50-ALK SEE LAST PAGE

- Phillips screwdriver
- Flashlight or droplight
- Teflon tape
- Protective eye wear (i.e. goggles)

If the above tools are not available, contact your local dealer/distributor for assistance.

REVERSE OSMOSIS SYSTEM INCLUDES

1. Reverse Osmosis System
2. FLOWLOK™ - Safety Tray
3. FLOWLOK™ - Leak Detector
4. SHOKBLOK™ - System Protection Valve*
5. Storage Tank
6. LF-EC23 Faucet (with mounting hardware)

FLOWLOK™

USA Patent Number: US 9,212,787 B1

** The Shok Blok is a pressure limiting device that works under flow to help protect water filtration devices, water coolers, ice machines and other devices from the effects of water hammer. Shok Blok is NOT a pressure regulator. Static pressure will equalize with no flow through device.*

PARTS (already pre-installed to R.O. system)

7. Connection Tubing
8. 5 Micron Sediment Prefilter
9. 5 Micron Carbon Block Prefilter
10. 50 Gallon per day Membrane
11. 5 Micron Carbon Block Post Filter
12. Inline Flow Restrictor
13. Fixed Elbow

ACCESSORIES (Included in installation packet)

14. Feed Water Adapter
15. Tank ball valve
16. Drain saddle

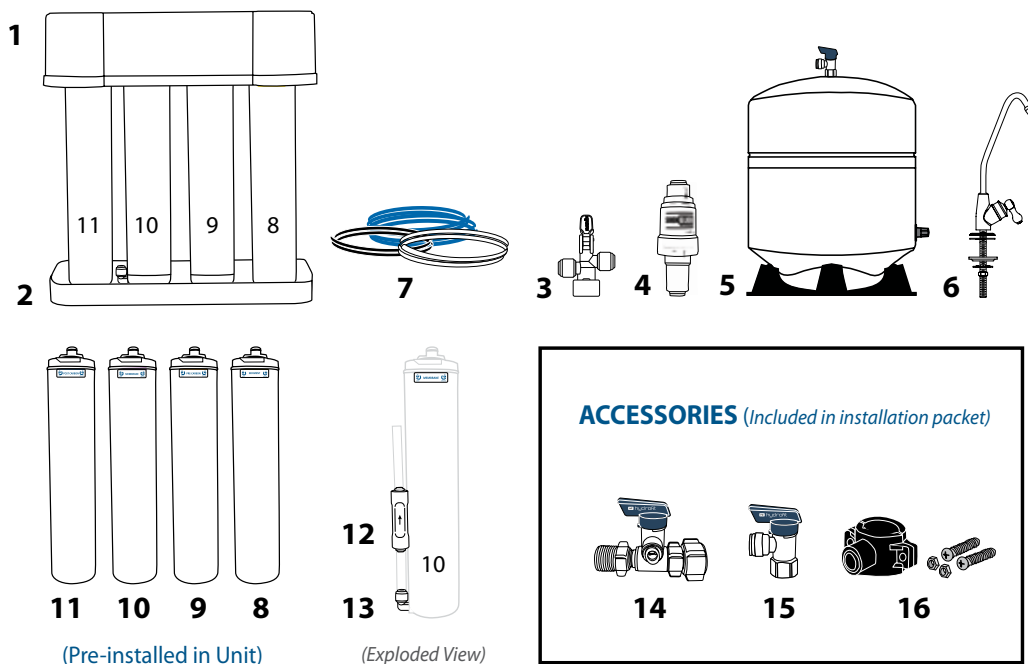

 **WARNING!!** The following conditions for feed water supply must be met or Warranty will be void.

1. Unit **MUST** be connected to a municipal or well water source that is treated and tested on a regular basis to insure water is microbiologically safe.
2. Operating temperatures:
 Maximum: 105° F (40.6° C)
 Minimum: 33° F (0.55° C)
3. Inlet Pressure **MUST NOT EXCEED** 80 PSI (5.6 kg/cm²)

 **CAUTION!! DO NOT ALLOW SYSTEM TO FREEZE.** The membrane always contains water and will be destroyed if frozen.

 **WARNING!! DO NOT PLUMB SYSTEM TO HOT WATER.** This will destroy the membrane and void the Warranty and manufacturer's responsibility.

4. Operating pressure:
 Maximum: 80 PSI (5.6 kg/cm²)
 Minimum: 40 PSI (2.95 kg/cm²)

This reverse osmosis system is designed to operate at a water pressure in the range of: 40 to 80 PSI (2.95 kg/ cm² to 5.6 kg/ cm²).

- At pressures lower than this, the quantity as well as quality will be reduced.
- At higher pressure, severe, damage to the system may result.

A pressure regulator **MUST** be installed on the feed water source, which reduces the water pressure coming into the system.

 **WARNING!!** Warranty voided and manufacturer assumes no responsibility for damage to system or property if pressure exceeds 80 PSI.

5. Turbidity: <5 NTU
6. pH: 4 to 11
7. Recommended hardness **NOT TO EXCEED** 7 grains per gallon, or 120 PPM.

(If the hardness of your water is above 10 gpg (171mg/L), lime scale will build up rapidly on the membrane. Scale buildup will plug the membrane and make the system ineffective. We do not recommend these reverse osmosis systems be used with water in excess of 10 gpg (171 mg/L) hardness, unless the water is softened prior to the reverse osmosis system.)

- Sulfide, Iron and Manganese: less than 0.01 ppm.
- Chlorine In Water Supply: less than 2 ppm.
- Water Supply pH Limits: 4-11.
- Turbidity: 1 NTU Max.

RECOMMENDATION: If your water hardness exceeds 7 grains per gallon, or 120 PPM you may wish to purchase a water softener. Contact your local dealer or distributor for pricing and availability.

8. Recommended Total Dissolved Solids (TDS) **NOT TO EXCEED** 1,000 ppm.

SPECIFICATIONS FOR REVERSE OSMOSIS SYSTEM

- **System Dimensions:** 3.75" w x 4.75" d x 12.75" h
(349 mm x 121 mm x 318 mm).
- **System Weight:** 6.1 lbs. (2.7 kg).
- **Tank Dimensions:** 11.3" d x 16.75" h
(287 mm x 425 mm) (with valve).
- **Tank Capacity:** 1.9–3.2 gal. (7.2–12.1L)
(Depending on water pressure).
- **Tank Weight:** Full - 40 lbs. (18.2 kg.)
(Depending on water pressure).

PLUMBING SCHEMATIC FOR REVERSE OSMOSIS SYSTEM

(Twist Reverse Osmosis System - 4 Stage, 4 Stage with Pump)

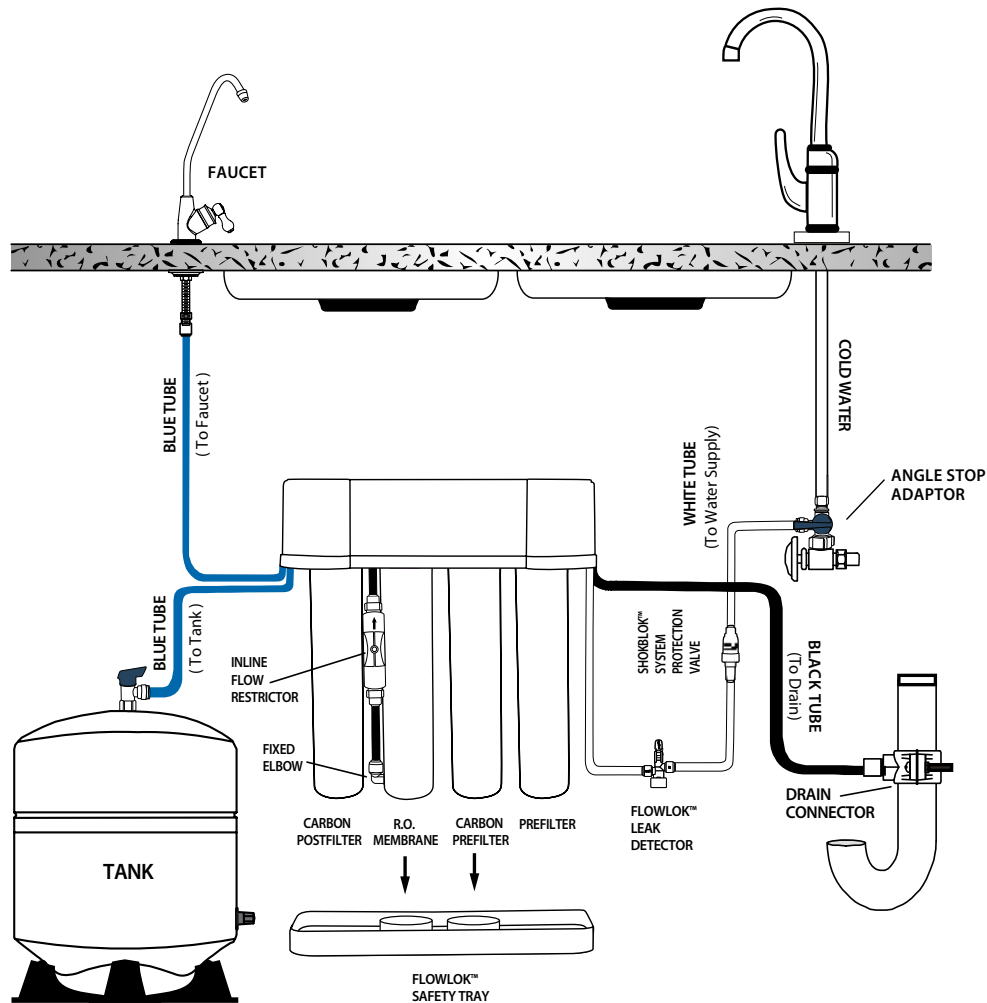

NOTE: The reverse osmosis system may be mounted to the side of the sink cabinet or set on the floor of the sink cabinet near the faucet tube to maximize flow rate

⚠ IMPORTANT!! PLEASE READ, FOLLOW AND SAVE THIS INSTRUCTION MANUAL.

1. PRE-INSTALLATION PROCEDURE

1. This unit includes a standard sink top faucet without an air-gap. In localities where plumbing codes require installation of an air-gap, contact your local distributor to obtain a code approved drain line adapter.
2. The reverse osmosis system may be mounted to the side of the sink cabinet or set on the floor of the sink cabinet. It must be positioned to allow access for service and filter changes. The assembly should be relatively near the faucet to maximize flow rate. (See *DIAGRAM A* for a positioning example.)
3. The storage tank should be located where it can be removed if necessary. The storage tank may be placed in either the vertical or horizontal position without affecting the system performance. If there is insufficient space under the sink for placement, the tank may be located in an adjacent cupboard up to 50 ft. away. (See *DIAGRAM A* for a positioning example.)
4. The faucet should be positioned to allow a free flow pattern into the sink. It must be positioned to allow ready access to the mounting hardware under the sink. (See *DIAGRAM A* for a positioning example.)

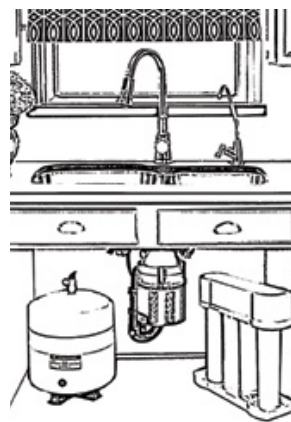

DIAGRAM A

2. FAUCET INSTALLATION

⚠ CAUTION!! Extreme care must be taken in drilling the hole for the sink-top faucet. The surface material of most sinks is extremely hard and brittle and can be easily chipped or cracked. If you are uncomfortable performing the following procedure it is recommended that your local distributor or experienced plumber be consulted for techniques, installation or other assistance. The system's manufacturer accepts no responsibility for sink top damage resulting from system installation. **EXTREME CAUTION SHOULD BE TAKEN WITH GRANITE, MARBLE AND LIKE MATERIAL.**

👁 CAUTION!! Before grinding or drilling put on appropriate eye protection (i.e. goggles) to protect yourself from porcelain or metal chips.

⚠ CAUTION!! To avoid damaging the sink, consult a qualified plumber or installer for drilling procedures. Special drill bits may be needed for porcelain or stainless steel.

⚡ WARNING: Many homes are electrically grounded through the plumbing. To protect yourself from serious injury or fatal shock, use a battery-powered hand drill only to make the hole. **DO NOT USE AN ELECTRIC DRILL.**

1. **BEFORE DRILLING:** Check under the sink in the area that you plan to install the faucet and make sure that there is a flat surface to secure the mounting hardware. A flat space of approximately 2 inches in diameter is needed.

RECOMMENDATION: Before drilling or grinding mask off the immediate area surrounding the grinding/drilling location preferably with duct tape or if duct tape is unavailable masking tape may be used. This procedure should help prevent scratching of the sink surface.

2. REMOVE EVERYTHING FROM INSIDE THE SINK AND SURROUNDING AREA. Place paper towels in the sink to catch the shavings from the grinding and drilling.
3. Using a cordless drill with a carbide grinding burr, gently grind away enough porcelain or enamel to more than accommodate the 7/16" (11 mm) drill bit. Approximately the size of a dime. Enough surface material must be removed to expose the base metal.



CAUTION!! Porcelain or enamel must be completely removed in the drilling area to prevent immediate dulling of drill bit.

4. Remove everything from under the sink.
5. Place newspaper or paper towels directly under drilling location in order to catch the drill shavings.
6. Using the 1/4" (6 mm) drill bit, drill a centering or pilot hole in the center of the desired faucet location.

NOTE: this centering/pilot hole will make it easier for the 7/16" (11 mm) drill bit to cut through the sink. Operate the drill slowly and carefully— Especially when the drill bit is about to penetrate the metal. Otherwise, damage to sink may occur. Use lubricating oil to keep the drill bit cool while drilling.

7. Discard paper towels and newspaper used in sink and below sink. Be very careful not to drop any shavings in sink or on the floor as they will oxidize and stain surfaces very quickly.

HELPFUL HINT: If you notice any rust spots from dropped shavings you should be able to get rid of them by scrubbing them with a cleaning chemical.

8. Cover the drilled hole with your finger **BE VERY CAREFUL NOT TO CUT YOURSELF ON SHARP EDGES!** Rinse sink then scrub with cleaner to prevent any rusting from shavings and to prepare for faucet installation. Plug hole again while rinsing off cleaner. Hole must be plugged in order to avoid water dripping below into sink cabinet, which may cause damage.
9. Remove faucet from package.

For steps 10-14 refer to DIAGRAM B on page 8.

10. Slip the small, thin rubber gasket over the faucet shank. Next slip the chrome trim plate (escutcheon plate) over the faucet shank. Finally, slip the large, thin rubber gasket over the faucet shank.
11. Place the faucet shank complete with only hardware installed in step 11 through the drilled hole.
12. From under the sink slip the large, black plastic, locating washer over the faucet shank. Next, slip the lock washer over the faucet shank followed by the thin chrome nut.
13. While holding the faucet assembly above the sink tighten the chrome nut below the sink with an adjustable wrench. Tighten the chrome nut until the faucet assembly does not move.



CAUTION!! DO NOT OVERTIGHTEN THE CHROME NUT. Overtightening can cause damage to the sink or faucet assembly.

DIAGRAM B

(For Faucet Installation Steps 10-14)

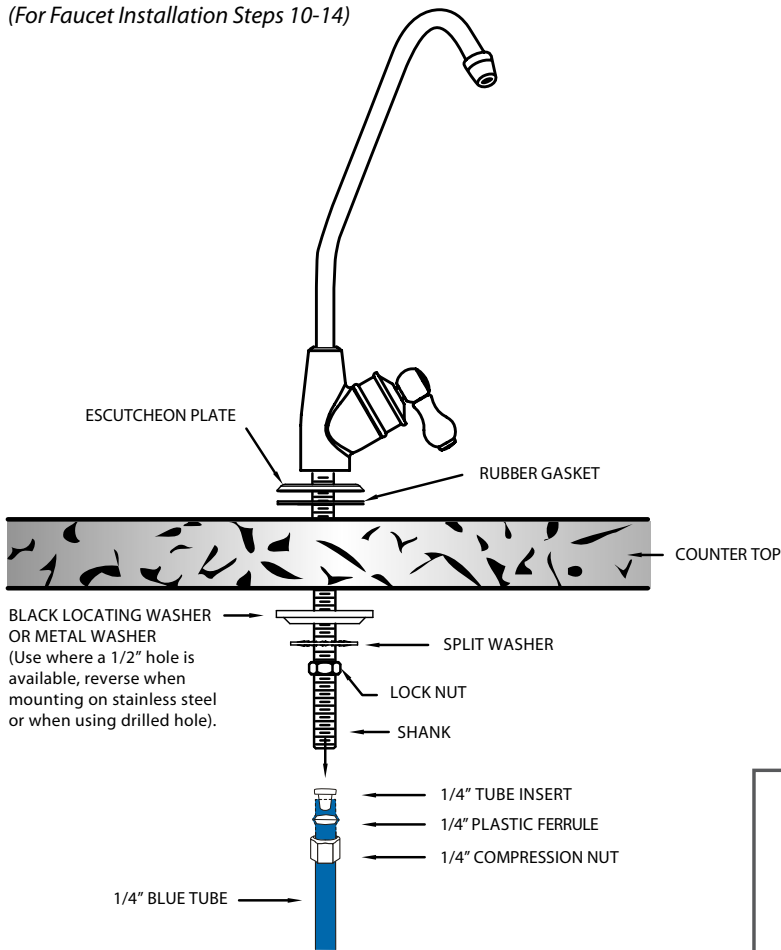

DIAGRAM C

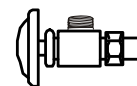

DIAGRAM D

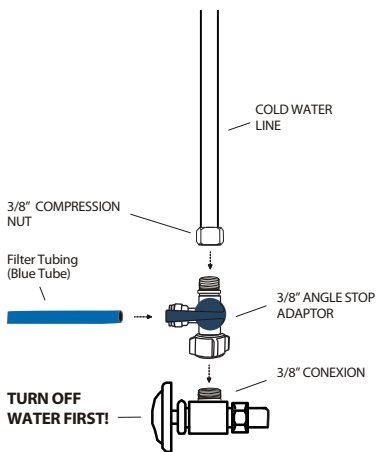
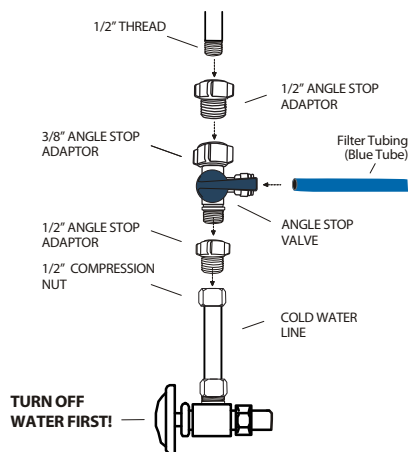

DIAGRAM E



3. INSTALLATION OF FEED WATER ADAPTER



CAUTION!! For your safety and protection, do not use where water is microbiologically unsafe or of unknown quality. The water supply to your system **MUST** be from the **COLD WATER LINE!** Hot water will severely damage your reverse osmosis system!

If you have a self-piercer assembly skip to step # 7 on page 10.

1. Turn off cold water supply to the sink using the supply valve located under the sink.

NOTE: In some cases the supply valve may leak or may not work at all. If this happens turn off the water at the main water shut off for the entire house. In extreme cases the house shut off valve does not work. If this happens shut the water off at the street and replace the defective valves immediately. Locate the type of shut off valve you have under your sink and follow that step for connecting the feed water.

2. Some shut off valves have an extra port for an icemaker hookup. You will not need the feed water adapter for this type of installation. (See *DIAGRAM C*)
3. On some shut off valves you can install the feed water adapter directly to the valve. Tighten feed water adapter to the valve with an adjustable wrench. Tighten until snug. Insert the 1/4" nylon elbow fitting into the feed water adapter. **TIGHTEN BY HAND ONLY! DO NOT OVERTIGHTEN!** (See *DIAGRAM D*)

Most under sink shut off valves have a built in smooth or corrugated riser going up to the faucet. (Refer to *DIAGRAM E* for help with this type of valve.)

Secure an adjustable wrench to the fitting on the cold water side of the sink faucet -- NOT THE R.O. Faucet! Secure another adjustable wrench to the smooth/corrugated riser line nut. Gently undo the riser line from the sink faucet. Do not be alarmed! There will be water left in the line—this is normal. However, if the flow does not stop you probably haven't shut the water off properly.
(See the *NOTE* in Step # 1, Section # 3 if you need help with water shut off.)

4. Screw the two supplied 1/2" adapters onto the fitting coming from the cold water side of the sink faucet. Hand tighten the feed water adapter to the cold water line. Take extreme care not to twist or damage the connection to the cold water connection.



CAUTION!! Tightening the connector improperly to the faucet could cause irreparable damage to the faucet.

5. Connect the riser from the water shut off valve to the feed water adapter. Ensure that the cone washer on the riser tube is in good condition. Connect the riser to the feed water adapter. **DO NOT OVERTIGHTEN!** This can cause damage to the riser connection.
6. Insert the 1/4" white tube into feed water adapter and then into the SHOK BLOK™ provided. (If not already inserted into the SHOK BLOK™)

Follow steps 7 and 8 below if not already Pre-installed:

7. After installing the SHOK BLOK™ (be sure to follow flow direction) insert white tubing into the "IN" on the FLOWLOK™ safety device.
8. From the "OUT" on the FLOWLOK™ device insert 1/4" white tubing to the inlet of the system.

9. Self-piercer assembly can only be installed on smooth riser lines.
(Sold Separately)
10. Clamp the self-piercer onto the riser tube. Fit the adjustable aluminum bracket to the size of your riser tube. Then tighten locking nut until clamp is firmly attached to riser line.



CAUTION!! Do Not Overtighten!! This will crush the riser tube and destroy it.

11. To pierce the line simply screw the T-handle valve clockwise until it stops.

NOTE: If hole in copper tube (cold water line) is not adequately pierced, this may prevent sufficient cold water supply to the system and reduce the performance of R.O. processing. In this event, open and close the self-piercing valve several times.

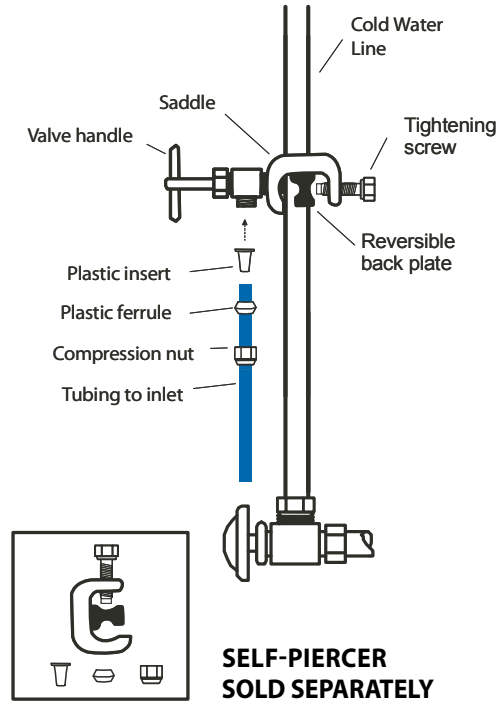

4. INSTALLATION OF FLOWLOK LEAK CONTROL VALVE

(If pre-installed, skip this steps)

FLOWLOK is a specially designed shut off valve that turns off your water when a leak is detected. The FLOWLOK valve uses a compressed textile disc which expands upon water contact and pushes the valve lever up to the closed position to stop all water flow into the drinking water system.

NOTE: The FLOWLOK will not shut off any water leak originating from the stop valve or any other connection which feeds water to it. FLOWLOK is designed to shut off water which is going into the drinking water system. (Please note that you can order replacement textile discs through you local dealer in case a disc accidentally becomes wet and expands.)



WARNING!!! The FLOWLOK valve **MUST** be installed to prevent any water leaks occurring from the drinking water system. Failure to install the FLOWLOK valve will automatically void the product warranty.

1. Locate compressed textile disc and set aside.
2. Place FLOWLOK into fixed position in tray and screw down. (If tray not use proceed to step 3).
3. Place FLOWLOK 2 inches from side wall of cabinet and 4 - 6 inches from the drinking water systems inlet side.
4. Affix the FLOWLOK with screws to the cabinet base (floor) with screws.
5. Lift FLOWLOK Lever to off position.
6. Once final connection is made, remove lever pusher and insert textile disc with the pronounced part towards the bottom and reinsert lever pusher. Lower on/off lever to allow water to flow thru the system.

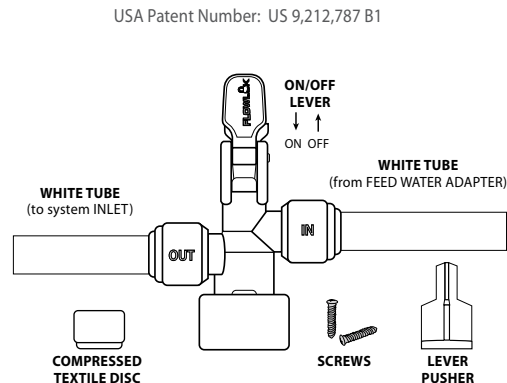

To view FLOWLOK video go to:
<http://hydronixwater.com/flowlok-products>



5. INSTALLATION OF DRAIN SADDLE

1. Open the package containing the drain saddle. (See *DIAGRAM F*)
2. Peel the protective film off of the sponge gasket. Apply gasket to inside of drain saddle, using care to align sponge gasket hole with drain port.
3. Position the drain saddle on the vertical or horizontal drainpipe from your sink. Position as far away from the garbage disposal as possible.

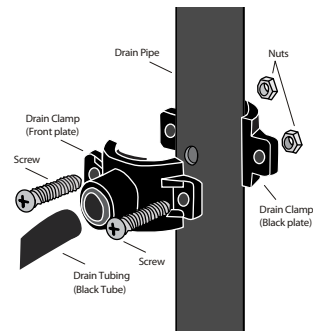

DIAGRAM F

⚠ DANGER!! The drain saddle **MUST** be installed on the side of the P-trap that goes to the sink drain!! If installed on the wrong side of the P-trap sewer gas could enter the unit and damage it.

⚠ CAUTION!! DO NOT INSTALL THE DRAIN LINE DOWNSTREAM OF A DISPOSER OR IN A HORIZONTAL PIPE.

4. Drill 1/4" (6mm) hole into the drainpipe.

⚠ CAUTION!! Be very careful when drilling into drainpipe to not drill all the way through—stop after piercing the first wall of the pipe.

5. Mount the drain saddle. Align the drain saddle port with the 1/4" drilled hole using a small drill bit or other small straight object.



6. **GENTLY TIGHTEN** the two screws evenly on both sides of the clamp until the clamp is snug on the pipe.

CAUTION!! To avoid breaking plastic saddle or crushing drainpipe **DO NOT OVERTIGHTEN!**

6. TANK PLACEMENT

1. Wrap 4 to 5 wraps of Teflon tape around the tank threads at the top of the tank.
2. Hand tighten the plastic shut off ball valve to tank stem.



CAUTION!! Hand tighten the valve only! **DO NOT OVERTIGHTEN!** If valve is overtightened it will crack and will leak.



IMPORTANT!! The tank pressure must be between 8-10 PSI when measured empty. This must be measured with a good dial or digital pressure gauge. A pop-up tire gauge will not give you an accurate reading. If you do not have access to a good gauge contact your local distributor to purchase one. If your tank pressure is above 10 PSI use the tank Schrader valve to release pressure until there is between 8-10 PSI. If your tank pressure is below 8 PSI use a bicycle pump or compressed air to increase pressure to between 8-10 PSI.

3. The storage tank should be located where it can be removed if necessary. The storage tank may be placed in either the vertical or horizontal position without affecting the system performance. If there is insufficient space under the sink for placement, the tank may be located in an adjacent cupboard up to 50 ft. away.

7. R.O. UNIT PLACEMENT AND MOUNTING

1. Determine if mounting of the reverse osmosis system is necessary or desired. The system does not need to be mounted on the wall of the cabinet if there is room for it to sit on the floor. However, if it is mounted to the side of the cabinet it is easier to change the filters and does not take up floor space.



IMPORTANT!! Be very careful not to kink any of the tubing on the reverse osmosis system. If tubing is kinked the tubing can rupture and leak.

2. Position the system on the wall at the desired mounting location 2 - 3 inches from base of cabinet. Using the bracket holes on the back of the bracket, mark on the wall with a pencil where the screws need to be inserted.
3. Set the system aside.
4. Screw the two (2) Phillip head screws (supplied in the installation packet) into the wall at the marked positions.

NOTE: Let the screw heads protrude from the wall enough to hang the reverse osmosis system safely.

5. Mount the reverse osmosis system onto the screws.

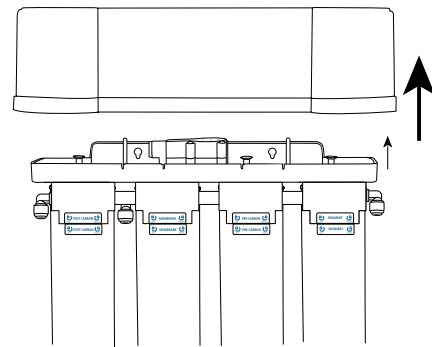

**LIFT COVER TO REVEAL
BRACKET HOLES**

8. TUBING CONNECTIONS



IMPORTANT!! Be very careful not to kink any of the tubing on the reverse osmosis system. If tubing is kinked the tubing can rupture and leak.

CONNECTING THE SYSTEM:

(BLUE TUBING - From system faucet port. This is from port labeled faucet)

1. Connect the blue tubing to the faucet by slipping the 1/4" chrome nut over the tubing followed by the nylon ferrule.

NOTE: It is not necessary to have a 1/4" nylon insert in this line as it would restrict the flow through the faucet.

2. Push the blue line all the way into the faucet stem and tighten the chrome nut.
DO NOT OVERTIGHTEN!!

CONNECTING THE FEED WATER:

1. Locate the cold water angle stop, turn off cold water and open cold faucet line to de-pressurize.
2. Once de-pressurized remove 3/8" line from your "COLD" water angle stop, screw the Feed water adapter onto the 3/8" angle stop hand tight.
3. Replace 3/8" line from above onto the Feed Water adapter male side and tighten accordingly.

4. Insert one end of the extra piece of white tubing into the inlet of the feed water adapter.
5. From the inlet of the Feed Water Adapter connect the white tubing to the SHOK BLOK™ system protection valve and ensure the flow arrow is in the correct direction towards the unit.

Follow steps 6 and 7 if not already Pre-installed:

6. From the out let of the Shok Blok™ connect one side of the white tubing to the port marked "In" on the flow lok leak control valve.
7. From the "out" port on the FLOWLOK™ leak detector connect the white tubing to the RO system marked "In".

CONNECTING THE TANK:

(BLUE TUBING - From system tank port)

Slide a white 1/4" chrome nut over the blue tubing and insert the 1/4" nylon insert into the end of the tubing. Then insert the tubing into the ball valve on the top of the storage tank. Tighten securely. **DO NOT OVERTIGHTEN!**

CONNECTING THE DRAIN SADDLE:

(BLACK TUBING - From system drain port)

Slip the 1/4" black chrome nut over the black tubing and insert into the drain saddle. Tighten securely. **DO NOT OVERTIGHTEN!**

NOTE: It is not necessary to have a 1/4" nylon insert in this line as there is no pressure on this line.

HOW TO MAKE QUICK CONNECT FITTINGS CONNECTIONS

1. CUT THE TUBING

-Cut the tube cleanly and squarely. Ensure that the tube has a smooth outside diameter without any burrs, chamfers or score marks prior to inserting it into the fitting. Tubing that has not been cut properly can cause drips and leaks.

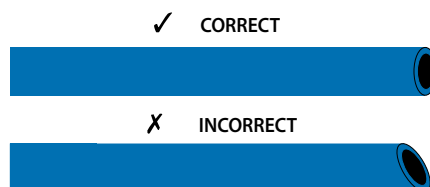

(Continues on page 14...)

HOW TO MAKE QUICK CONNECT FITTINGS

CONNECTIONS: (Continued)

2. INSERT TUBING

Push the tubing through the collet and o-rings until it bottoms out against the tube stop. The collet holds the tube in place and the o-ring provides a leak resistant seal. If you need to remove the tubing always re-cut before connecting tubing again. Scores on tubing can cause failure.

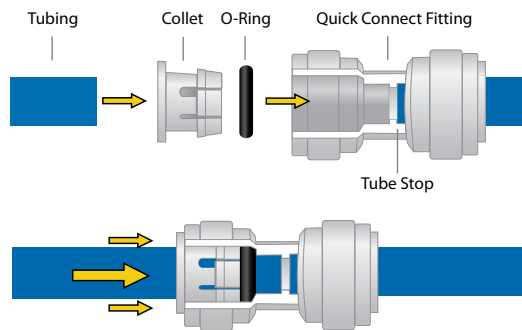

3. INSPECT AND TEST

Push and pull the tubing toward and away from the fitting to ensure that it has been installed properly. Test and inspect the installation for any leaks.

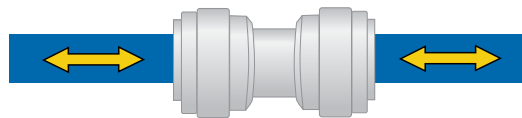

4. TUBE REMOVAL

Relieve pressure from the tubing and fitting. Push the collet flange against the fitting body while pulling the tubing away from the fitting to release it.

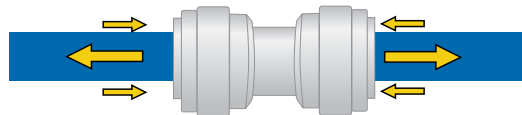

CAUTION!! IT IS RECOMMENDED THAT TUBING AND QUICK CONNECTION FITTINGS INSTALLATIONS ARE INSPECTED A MINIMUM OF ONCE PER YEAR AND PARTS REPLACED AS NEEDED.

9. SYSTEM START-UP

1. With all connections complete, turn on the cold water supply to the reverse osmosis system



IMPORTANT!! The Reverse Osmosis Main Water Shut Off valve (*indicated by the bright orange tag at the side of the unit*) must be open. This means the blue handle on the valve must be in the horizontal position.

2. Immediately check entire reverse osmosis system and tank for leaks. If you notice any leaks turn off cold water supply and fix the leak.



IMPORTANT!! Ensure that the ball valve on the storage tank is open. This means that the valve handle is in line with the white tubing.

3. Once no leaks have been determined. Lift the lever on the Flowlok Valve and place compressed textile disc in holding cup and lower lever to allow water back into the system.

10. FLUSHING THE R.O. SYSTEM

1. The tank will fill in approximately 4-5 hours.
2. After the tank has filled, open the faucet and drain all the water from the tank until it is empty.
3. Within 2-3 hours after draining the first tank of water the water is ready for drinking.



CAUTION!! DO NOT USE FIRST TANK OF WATER FROM YOUR SYSTEM! The membrane contains a food grade preservative to protect it while in storage. This preservative is not harmful, however it does not have a pleasant taste. Therefore, do not use the first tank of water, which flushes the entire system removing any preservatives used during storage and preparing it to produce quality water.



CAUTION!! If installing the unit in new construction, ensure that house plumbing is flushed thoroughly before opening the water supply valve.



WARNING!! Discard all unused parts and packaging material after installation. Small parts remaining after the installation could be a choke hazard.

11. FILTER REPLACEMENT INSTRUCTIONS

STEP 1

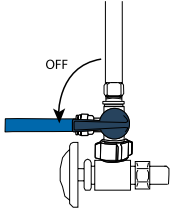

TURN WATER OFF

Shut-Off the water supply and tank valve. Open the faucet and let water run to approx. 1-2 minutes to depressurize the system

Note: Place a towel or rag under the system to avoid water spills

STEP 2

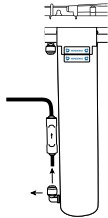

DISCONNECT

Remove black Tubing with Inline Flow Restrictor and Fixed Elbow from Membrane

Note: See Section 8 on Page 14 for Tubing connection and disconnection instructions

STEP 3

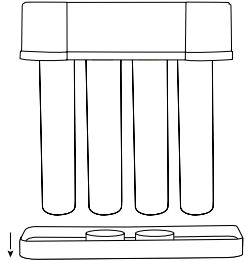

REMOVE TRAY

While the system is still mounted pull down on the safety tray and remove it.

CAUTION: Please be careful with tubing connections especially if system is not mounted.

STEP 4

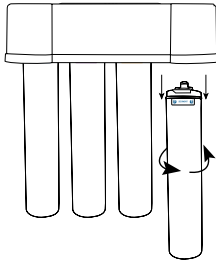

TWIST-OFF

Twist-off (towards the right) by hand each cartridge and pull down to remove

STEP 5

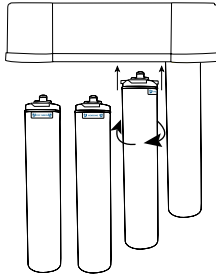

REPLACE FILTER

Insert and twist (towards the left) a new cartridge back on by hand. Cartridges labels must match and align.

Note: Make sure to discard all used cartridges according to your local law.

STEP 6

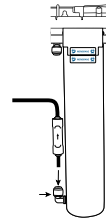

RECONNECT

Reinsert black Tubing with Inline Flow Restrictor and Fixed Elbow to Membrane

(Flow arrow on Flow Restrictor MUST face up)

STEP 7

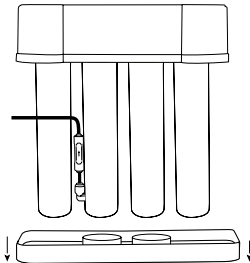

TRAY BACK ON

Insert safety tray back on by securing two of the middle cartridges down with hardware provided

STEP 8

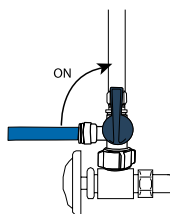

TURN WATER ON

Turn-On the water supply and tank valve (Blue handle horizontal position)

STEP 9

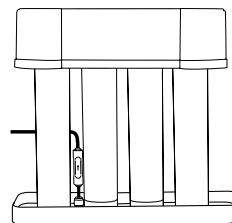

PURGE SYSTEM

See page 13 (Section 8 & 9) for instructions.

Note: Remove towel/rag once system has run and no leaks have been found

REVERSE OSMOSIS SYSTEM REPLACEMENT FILTERS

4 stage filtration offers you 5 Stage quality with only 4 filters to replace!



STAGE 1

SEDIMENT HDGT-SED5

Replace Filter Every:
6 months - 1 year

Five Micron Sediment Prefilter reduces dirt, sand, silt, sediment, and rust.



STAGE 2

PRE-CARBON HDGT-CB5

Replace Filter Every:
6 months - 1 year

Five Micron Coconut Shell Carbon Block Prefilter reduces chloramines, chlorine taste, and odor.



STAGE 3

MEMBRANE HDGT-TW50

Replace Filter Every:
2 years

50 Gallon Per Day - Semi permeable Reverse Osmosis Membrane for reduction of dissolved solids, including a wide range of toxic heavy metals like lead and Pentavalent arsenic, Giardia Lamblia, Cryptosporidium cysts, Barium, Cadmium, Copper, Hexavalent & Trivalent Chromium, Cyst, Fluoride, Nitrate/Nitrite, Radium 226/228, Selenium, TDS and Turbidity. *Patent Pending*



STAGE 4

POST-CARBON HDGT-CB5P

Replace Filter Every:
6 months - 1 year

Five Micron Coconut Shell Carbon Block Post/Polishing Filter works as a final stage filter for great tasting crystal clear water.

NOTE: The life of the filters and membrane depend on the quality of water supplied to the reverse osmosis system.

12. PUMP HOOK UP

1. Cut the white line going to your tank.
2. Take the union tank shut-off switch (TSO) and connect one side of the union to right side of cut tubing. Connect the other side of the union to the left side of the cut tubing.
3. Connect the TSO wire harness to the pump wire harness.
4. Plug the transformer wire harness to the pump wire harness.
5. Once secure, plug the transformer into an appropriate voltage electrical outlet.

TROUBLESHOOTING

NOT ENOUGH WATER FROM HOLDING TANK

POSSIBLE	CAUSE / SOLUTION
Feed water valve is plugged or closed.	Open valve or unclog.
Sediment/Carbon prefilter or Carbon Post Filter is clogged.	Replace Filters.
Low incoming water pressure.	Incoming water pressure must be above 40 PSI. Install a Booster Pump or Permeate Pump.
Reverse Osmosis Membrane is fouled.	Make sure incoming water pressure is within operating limits. Make sure drain line is not clogged. (See High TDS) Correct cause of fouling and replace RO Membrane.
Air pressure in holding tank is incorrect.	Empty water from holding tank. Air pressure in valve stem should be between 8 - 10 PSI.
Air Bladder in Holding Tank is ruptured.	Replace Holding Tank.
Holding Tank valve is closed.	Open valve.
No water to drain. Drain Flow Restrictor is clogged.	Replace Drain Flow Restrictor.
No water to drain. Air Gap Faucet is clogged.	Clear or replace Air Gap Faucet.
Check Valve on RO Membrane Housing is stuck.	Replace Check Valve.
The Automatic Shut-Off Valve is Malfunctioning.	Replace Automatic Shut-Off Valve. Replace Automatic Shut-Off Valve.

LOW WATER PRESSURE FROM DISPENSING FAUCET

POSSIBLE	CAUSE / SOLUTION
Air Pressure in Holding Tank is incorrect. This is the #1 reason for low flow from Reverse Osmosis Faucet.	Open faucet and empty water from holding tank. Shut off feed water to system and remove holding tank from under sink. (The tank is easier to work on.) Locate the air valve stem (just like on a car or bicycle tire) and add air. If there is still water in the tank, continue to add air until all the water is removed. Once all the water is removed, continue to add air and pressurize to 8 PSI. Re-install the tank under the sink, turn on the feed supply to the system and allow the tank to fill.
Carbon Post Filter is clogged.	Replace Post Filter.
Holding Tank Valve is partially closed.	Open Valve.
The Faucet is out of adjustment or faulty.	Repair or replace Faucet.
Heavy water use. Holding Tank is empty.	Allow Holding Tank to refill.
Low Water Production.	See previous section on Low Quantity of Water From Holding Tank.

TASTES AND ODORS IN PRODUCT WATER

POSSIBLE	CAUSE / SOLUTION
Carbon Post Filter is exhausted.	Replace Filter.
There is foreign matter in Holding Tank.	Clean, flush and sanitize the Holding Tank. Replace filters.
Product water and Drain water lines are reversed.	Correct plumbing.
Dissolved gases in feed water.	Pre-treat feed water to remove gases.
Increase in Product Water TDS.	See next table: High TDS in Product water and drain water lines are reversed CAUSE / SOLUTION Section.

DRAIN WATER OVERFLOWS AT THE AIR GAP FAUCET

POSSIBLE	CAUSE / SOLUTION
Air Gap is clogged.	Clear Air Gap
Drain line is clogged.	Clear tubing.
Drain flow rate is too high.	Replace Flow Restrictor.

PRODUCT WATER IS HIGH IN TOTAL DISSOLVED SOLIDS (TDS)

POSSIBLE	CAUSE / SOLUTION
Clogged Prefilter.	Replace Filter.
Low incoming water pressure.	Incoming water pressure must be above 40 PSI. Install a Booster Pump or Permeate Pump.
Reverse Osmosis Membrane is not correctly sealed in Membrane Housing.	Check that RO Membrane is correctly installed.
Reverse Osmosis membrane is expended.	If Membrane life is unusually short, find and correct the problem. (Average life is 2 - 3 years.) Replace RO Membrane.
Product water and drain water lines are reversed.	Correct plumbing.
No water to drain. Drain Flow Restrictor is clogged.	Replace Drain Flow Restrictor.
No water to drain. Air Gap Faucet is clogged.	Clear or replace Air Gap Faucet.
The Automatic Shut-Off Valve is not closing.	Repair or replace Automatic Shut-Off Valve.
New Carbon Postfilter has not been rinsed completely.	Drain Holding Tank twice to rinse new Carbon Postfilter.
The incoming feed water TDS has increased.	An increase in feed water TDS will also give an increase in Product Water TDS.

FAUCET LEAKS OR DRIPS

POSSIBLE	CAUSE / SOLUTION
Water leaks from faucet spout.	Adjust faucet by turning the tee bar located under the handle to provide a small amount of free play in the handle when shut off. Should this not work, repair or replace the faucet.
Leaks from beneath the handle.	Repair or replace the faucet.

NO WATER

POSSIBLE	CAUSE / SOLUTION
Water is shut off at stop valve	Open main stop valve. (See diagram on page 15)
Flowlok is set to off position	Make sure Flowlok main lever is in OPEN position. Lever should be lowered. (See diagram on page 10)

REGISTRATION RECORD

(WARRANTY VOID WITHOUT REGISTRATION)

PLEASE FILL OUT FOR YOUR RECORDS

Purchased from: _____

Name: _____

Phone Number: _____

Street Address: _____

City: _____ State _____ Zip Code: _____

Country: _____

Email Address: _____

Purchase Date: _____ Model: _____

Purchase Installation Date: _____ Serial#: _____

Product Installed by: _____

(Check One Only)

Installed in:

Kitchen

Guest House

Bar Area

Garage

Basement

Break room

Other: _____

LIABILITY



WARNING!!! The installer is responsible for any leaks resulting from installation of tubing or related fittings. **THE INSTALLER MUST CHECK OVER THE ENTIRE SYSTEM COMPLETELY WHILE UNDER PRESSURE TO ENSURE SYSTEM IS NOT LEAKING AND FUNCTIONING PROPERLY.** Liability resulting from failure to check for leaks under pressure is the sole responsibility of the installer.

WARRANTY

THREE YEAR LIMITED WARRANTY ON REVERSE OSMOSIS DRINKING WATER SYSTEM (Except filter cartridges and R. O. membrane)

Warrantor guarantees, to the original owner, that the Reverse Osmosis Drinking Water System, when installed and maintained in accordance with the instructions, will be free from defects in materials and workmanship for a period of one year from date of installation. If, within the first year, a part proves, after inspection, to be defective, Warrantor will, at its sole option, either replace or repair the part without charge except normal shipping and installation charges. Labor to maintain the equipment is not part of the Warranty. Filters and membranes, which are expendable, are not covered by the Warranty.

This Warranty applies only while this product is in use in the United States or Canada.

General Provisions

The above warranties are effective provided the Reverse Osmosis Drinking Water System is operated at water pressures not exceeding 80 psi, and at water temperatures not exceeding 113°F; provided further that the Reverse Osmosis Drinking Water System is not subject to abuse, misuse, alteration, neglect, freezing, misapplication, neglect, alteration, water pressure spikes, accident or negligence; and provided further that the Reverse Osmosis Drinking Water System is not damaged as the result of any unusual force of nature such as, but not limited to, flood, hurricane, tornado or earthquake. Warrantor is excused if failure to perform its Warranty obligations is the result of strikes, government regulation, materials shortages, or other circumstances beyond its control.

*THERE ARE NO WARRANTIES ON THE REVERSE OSMOSIS DRINKING WATER SYSTEM BEYOND THOSE SPECIFICALLY DESCRIBED ABOVE. ALL IMPLIED WARRANTIES, INCLUDING ANY IMPLIED Warranty OF MERCHANTABILITY OR OF FITNESS FOR A PARTICULAR PURPOSE, ARE DISCLAIMED TO THE EXTENT THEY MIGHT EXTEND BEYOND THE ABOVE PERIODS. THE SOLE OBLIGATION OF WARRANTOR UNDER THESE WARRANTIES IS TO REPLACE OR REPAIR THE COMPONENT OR PART WHICH PROVES TO BE DEFECTIVE WITHIN THE SPECIFIED TIME PERIOD, AND WARRANTOR IS NOT LIABLE FOR CONSEQUENTIAL OR INCIDENTAL DAMAGES. NO WARRANTOR DEALER, AGENT, REPRESENTATIVE, OR OTHER PERSON IS AUTHORIZED TO EXTEND OR EXPAND THE WARRANTIES EXPRESSLY DESCRIBED ABOVE.

Some states do not allow limitations on how long an implied Warranty lasts or exclusions or limitations of incidental or consequential damage, so the limitations and exclusions in this Warranty may not apply to you. This Warranty gives you specific legal rights, and you may have other rights which vary from state to state. This Warranty applies to consumer-owned installations only. This Warranty does not cover any equipment that is relocated from the site of its original installation.

Alkaline Water Reverse Osmosis Systems

ATRO-450-ALK | ATRO-550-ALK | ATPRO-50-ALK

ICF Alkaline Series Inline Filters -

- Adds beneficial minerals back into water
- Increases alkalinity and negative ORP (Oxidation Reduction Potential)
- 2,000 gallon capacity



ICF ALKALINE SERIES FILTERS produce perfectly ph balanced alkaline water, helping to minimize fluctuations in your normal pH. Hydronix Alkaline Series filters Increase the antioxidant level (negative ORP) in your water to neutralize free radicals and DNA damage. Unlike regular water which has a positive ORP which could create damaging free radicals in your body, Hydronix Alkaline Series filters increase negative ORP levels to provide you with water that acts as an antioxidant. They increase the pH of drinking water from the tap to a range of about 8.5 to 10 (alkaline). There are many health benefits attributed to raising the pH level in the body and obtain a more alkaline state that optimizes the body's health. Hydronix Alkaline Filters add beneficial Calcium and Magnesium to the water while also increasing the water's ORP (antioxidant level).

INSTALLATION:

1. Connect FPT to Push-fit adaptaters to ICF-ALK inline filter.
2. Use the push-fit fittings to place your filter on the hose feeding the faucet from the reverse osmosis system. It is important that you ensure that your ICF-ALK is the final stage of filtrataion, the very last item the water flows through before it reaches the faucet. See diagram below.

ATRO-450 & 550

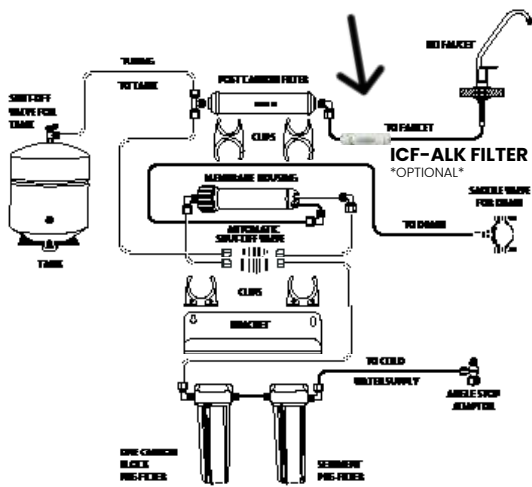

ATPRO-50

